

Work Clever. Click Together.

L-BOXX[®] ***Pro
Click***



Product Range

For fast and efficient work
MOBILITY WITH A SYSTEM



THE PROBLEM

THE SOLUTION

The craftsman works with a huge range of different machine cases, boxes, cartons and buckets. This means it can be difficult to monitor stock levels of consumables, transport is hard work, and every day lots of valuable time is lost during loading, unloading and securing cargo.

We have the solution: L-BOXX and ProClick – two mobility systems that are compatible with each other and guarantee fast and efficient work.

Through integration into the in-vehicle equipment systems of numerous well-known manufacturers, such as the market leader Sortimo, they can be stored safely and neatly in the vehicle.



L-BOXX®

More than just a BOXX
THE L-BOXX SYSTEM

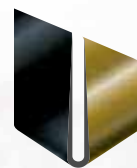

german
brand
award



The L-BOXX is much more than just a case – the universal mobility solution, with its numerous combination and expansion possibilities, is an intelligent transport and storage system.

The unbeatably simple and patented click mechanism of the various system products enables intuitive connecting, combining and separating in seconds, as well as clever transport and time-saving carrying in combination.

A well-thought-out range of accessories creates order and overview in the system. This way, nothing is forgotten that will later be needed on the construction site.

The modularly designed L-BOXX system offers everything that the professional craftsman needs for his daily work and that makes his work easier.

L-BOXX®

Versatile combination MIX AND MATCH



The various BOXXes and system products work together perfectly like a well-oiled team. That's why a host of well-known manufacturers use the L-BOXX system as intelligent outer packaging for their products, providing their customers with real value added.

Because no matter what colour the L-BOXXes are, they are all compatible with each other!

Instead of a confusing collection of different carrying cases and storage containers, professionals can create a uniform and fully compatible system – for easy handling and maximum mobility.

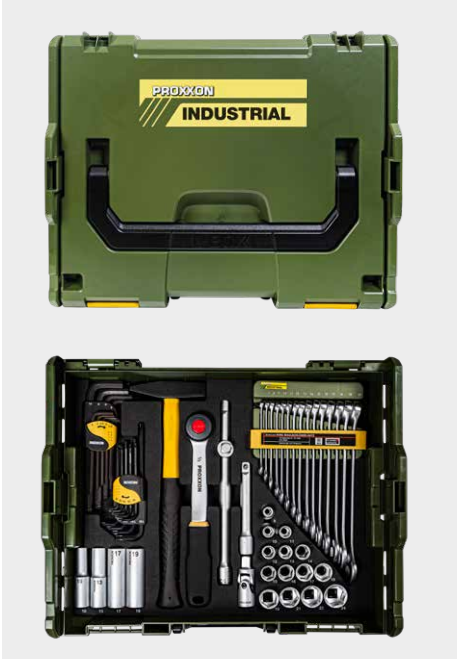

Our mobility system THE HARD FACTS

- The robust click mechanism and carrying handles permit L-BOXXes to be transported in bundles of up to 40 kg
- The lid can be loaded with up to 100 kg
- Each L-BOXX has a loading capacity of up to 25 kg
- Splash-proof
- Ergonomically shaped handles and additional side grips for flexible and convenient handling
- BOXXes are clicked together and separated with unbeatable ease



Thanks to its rugged design made from impact and shock-resistant ABS plastic, the L-BOXX can handle nearly every challenge and withstand even extreme loads. Making it ideally equipped for daily use on the construction site. Whether you need to transport heavy material, small parts, machines or tools, the L-BOXX brings everything to the place of use easily and conveniently.

The L-BOXX brand stands for more than just a toolbox available in four different sizes. It is the basis of a product family with a system concept.

We also follow this concept when designing the standardised accessories that let you individually adapt the BOXXes to suit your own needs.



Convenient transport in combination thanks to the patented click connection



Quick connection and disconnection of the BOXXes thanks to simple click mechanism



Power-saving and efficient transport to and from the construction site



Fully compatible with numerous manufacturers of vehicle equipment such as the market leader Sortimo



L-BOX® 102

L-BOX® 136

L-BOX® 238

L-BOX® 374

ProClick

Always everything at hand THE PROCLICK SYSTEM



- Unique mobility system with guaranteed one-hand operation
- Robust and tear-resistant material
- Safe transport due to simple and intuitive click click connection
- Quick access to all tools and consumables and still have your hands free
- Flexible, clear and tidy storage
- More safety through reflective safety strips



- Simple, reliable and flexible handling
- Individually combinable components
- High-quality and robust materials
- Compatible with the L-BOXX system
- Integration into the Sortimo in-vehicle equipment systems

ProClick is changing the way professional craftsmen carry their tools.

The ergonomically padded Tool Belt or simply your own trouser belt forms the basis – the ProClick holder is the heart and hub of the system. Unique: awkward threading and unthreading of the belt is a thing of the past thanks to ProClick. If necessary, the holder can be removed in no time at all or fastened to the belt with the clever quick-release system.

ProClick

Mobile working with a system
CLICK AND GO



The various tool bags, flexible storage solutions and robust holders, which are equipped with a so-called ClickUnit, can be clicked into place and firmly connected to the holder with a single movement. So you always have everything at hand and still have your hands free.

The heart and hub of the system:
the holder



SAFETY *Rocks*

Optimally
 protected.

The safety solution for lithium batteries

Whether cars, bicycles, power storage for renewable energies, power tools or electric gardening equipment - lithium batteries are being used more and more. The problem: Lithium batteries are considered dangerous goods and are therefore subject to the law on the transport of dangerous goods with strict criteria. The L-BOXX Battery SafeBOXX offers you the transport and packaging solution according to requirements.



Special regulations and packing instruction according to ADR

	Special provision	Packaging instruction	Licensing
Small, intact lithium batteries <100 Wh	SV188	-	✓
Intact lithium batteries >100 Wh	SV230	P903	✓
Prototypes	SV310	P910	✓
Batteries for disposal/recycling	SV377	P909	✓
Damaged/defective batteries	SV376	P908	✓
Critically damaged/defective batteries (unsafe for transport)	SV376	P911	✗



The L-BOXX Battery SafeBOXX is the transport and storage solution for lithium batteries.

- L-BOXX 238 made of special plastic compound with BAM dangerous goods transport certification (UN 3480)
- Stackable & clickable for space-saving storage and easy transport in combination
- Cirrux brand insert fits snugly to the battery and secures it from bumps and unintentional slipping around during transport
- Cirrux marker insert made of non-combustible (according to DIN 4102) and non-conductive material. The permeable surface absorbs leaked electrolytes into the padding material and binds them there (absorption capacity 3.49 kg). Heat generated by uncontrolled chemical reactions inside the battery is absorbed. The upholstery material is dust-free.
- Legally prescribed identification labels are clearly visible on the lid
- Simple load securing in vehicle racking systems from numerous well-known manufacturers, such as those from the market leader Sortimo.
- System BOXX made of high-quality and impact-resistant ABS plastic and lid carrying handle for easy handling
- Lockable by rope or padlock (not included in scope of delivery)
- Dust and splash-proof

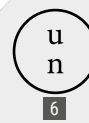
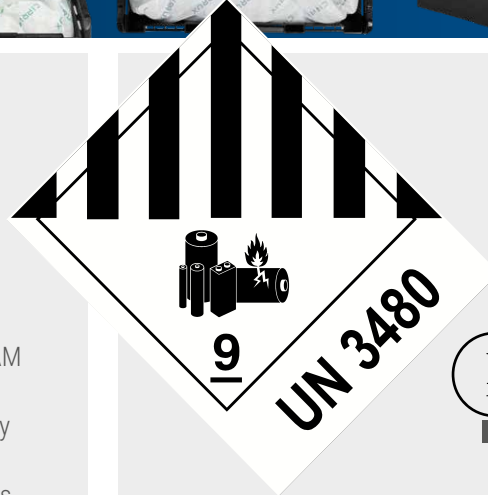

1	2	3	4	5
4H2/Y17/S/YY/D/				
BAM16024-BSS2				
7	8	9		

- 1 Packaging type and material
- 2 Packing group and gross mass
- 3 Fabric type
- 4 Year of construction
- 5 Admitting state
- 6 UN symbol for packaging
- 7 Admitting institution
- 8 Approval number
- 9 Abbreviation of the manufacturer or inspection body

Dangerous goods classification:

UN 3480: Lithium-ion batteries

UN 3481: Lithium-ion batteries in equipment or lithium-ion batteries packed with equipment

UN 3090: Lithium metal batteries

UN 3091: Lithium metal batteries in equipment or lithium metal batteries packed with equipment

Product	Description	RRP in € excl. VAT	Pallet unit	Item number
	Battery SafeBOXX ADR Colour: Black / orange Exterior in mm: W445 x D358 x H254 Interior in mm: W378 x D303 x H203 Weight in kg: 3.8	339.00	35	6100001162

L-BOXX 102 with transparent lid and matching accessories













L-BOXX 102 Transparent lid		RRP in € excl. VAT	Pallet unit	Item number
Colour:	black / anthracite	59.90	85	6100000362
Exterior in mm:	W445 x D358 x H118			
Interior in mm:	W378 x D313 x H61			
Weight in kg:	2.5			
Volume in litres:	8.6			

Tool box made of plastic with transparent lid for clear storage and protection during transport

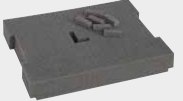
Unique mobility system • Patented click connection • Modular interior • Organized storage • Safe transport • Integration into the in-vehicle equipment systems of renowned manufacturers

Product	Description	RRP in € excl. VAT	Pallet unit	Item number
	Inset Box Set A3 LB 102 2x Inset Box U3 30x Inset Box A3	18.10	140	6000010090
	Inset Box Set B3 LB 102 2x Inset Box U3 15x Inset Box B3	18.10	140	6000010091
	Inset Box Set BC3 LB 102 2x Inset Box U3 3x Inset Box B3, 6x Inset Box C3	18.10	140	6000010092
	Inset Box Set CD3 LB 102 2x Inset Box U3 3x each of Inset Box C3/D3	18.10	140	6000010093
	Inset Box Set D3 LB 102 2x Inset Box U3 5x Inset Box D3	18.10	140	6000010094
	Inset Box Set F3 LB 102 2x Inset Box U3 7x Inset Box F3, 1x Inset Box B3	18.10	140	6000010095

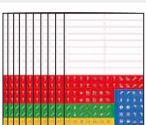
Product	Description	RRP in € excl. VAT	Pallet unit	Item number
	Inset Box Set G3 LB 102 2x Inset Box U3 2x each of Inset Box A3/B3/G3	18.10	140	6000010096
	Inset Box Set H3 LB 102 2x each of Inset Box U3/A3/C3/F3 1x Inset Box D3, 3x Inset Box B3	18.10	140	6000010097
	Inset Box Set K3 LB 102 2x Inset Box U3 2x Inset Box K3	18.10	140	6000010098
	Inset Box Set L-BOXX Mini LB 102 2x Inset Box U3, 2x L-BOXX Mini Transparent lid	30.20	140	6000010099
	Small Parts Insert 5 compartments LB 102 Made from 100% recycled polystyrene	4.50	160	6000002303
	Small Parts Insert 8 compartments LB 102 Made from 100% recycled polystyrene	4.50	160	1000010125
	Foam Insert LB 102 for individual adaption pre-perforated	15.60	140	6000003672
	Anti-Slip Mat LB 102/136 prevents scratches on the bottom of the BOXX and protects the contents	4.90	500	1000010122
	Divider Set 3F LB 102 metal frame and dividers for division into 3 compartments	21.60	360	1000010149
	Divider Set 4F LB 102 metal frame and dividers for division into 4 compartments	23.70	440	1000010150
	Shoulder Strap Set LB * adjustable carrying strap	22.20	400	6000003684
	Labelling Stickers 10 sheets (DIN A4) with 18 weather-resistant labels & 79 icons	32.00		6100000403



L-BOXX 102
with trans-
parent lid and
Inset Box Set
H3

L-BOXX 102 with
transparent lid
and Small Parts
Insert 8 compart-
ments

* Mounting material included

Valid from 01.03.2024 - all prices are recommended retail prices

W-BOXX 102



W-BOXX 102 Transparent lid IBS

Colour: black / anthracite
 Exterior in mm: W440 x D404 x H102
 Interior in mm: W386 x D311 x H77
 Weight in kg: 1.5
 Volume in l: 9.6

delivery including Inset Box set

RRP in € excl. VAT	Pallet unit	Item number
54.50	100	6100000371

Tool box made of plastic for clean storage and safe transport

Lightweight and robust • Tidy storage and quick overview thanks to transparent lid • Connectable to and compatible with the L-BOXX system • System packaging for price-sensitive products • Integration into the in-vehicle equipment systems of renowned manufacturers

L-BOXX 102 and matching accessories













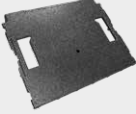

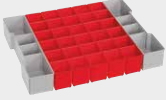
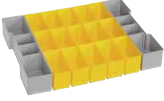

L-BOXX 102









Colour: black / anthracite
 Exterior in mm: W445 x D358 x H118
 Interior in mm: W378 x D313 x H65
 Weight in kg: 2.1
 Volume in litres: 8.8

RRP in € excl. VAT	Pallet unit	Item number
51.20	85	6100000305

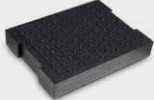
Tool case made of plastic for clear storage and protection during transport

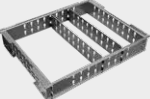
Unique mobility system • Patented click connection • Modular interior • Organized storage • Safe transport • Integration into the in-vehicle equipment systems of renowned manufacturers

Product	Description	RRP in € excl. VAT	Pallet unit	Item number
	Lid Insert LB for flush lid closure for Inset Boxes and small parts inserts	6.20	240	6000003670
	Lid pads XLB Enables form-fit loading in conjunction with the Honeycombs in the lid for form-fit loading	4.30	500	6100000296
	Inset Box Set A3 LB 102 2x Inset Box U3 30x Inset Box A3	18.10	140	6000010090
	Inset Box Set B3 LB 102 2x Inset Box U3 15x Inset Box B3	18.10	140	6000010091
	Inset Box Set BC3 LB 102 2x Inset Box U3 3x Inset Box B3, 6x Inset Box C3	18.10	140	6000010092
	Inset Box Set CD3 LB 102 2x Inset Box U3 3x each of Inset Box C3/D3	18.10	140	6000010093
	Inset Box Set D3 LB 102 2x Inset Box U3 5x Inset Box D3	18.10	140	6000010094
	Inset Box Set F3 LB 102 2x Inset Box U3 7x Inset Box F3, 1x Inset Box B3	18.10	140	6000010095
	Inset Box Set G3 LB 102 2x each of Inset Box A3/B3/G3/U3	18.10	140	6000010096
	Inset Box Set H3 LB 102 2x each of Inset Box U3/A3/C3/F3 1x Inset Box D3, 3x Inset Box B3	18.10	140	6000010097
	Inset Box Set K3 LB 102 2x each of Inset Box U3/K3	18.10	140	6000010098
	Inset Box Set L-BOXX Mini LB 102 2x Inset Box U3 2x L-BOXX Mini, transparent lid	30.20	140	6000010099
	Small Parts Insert 5 compartments LB 102 Made from 100% recycled polystyrene	4.50	160	6000002303
	Small Parts Insert 8 compartments LB 102 Made from 100% recycled polystyrene	4.50	160	1000010125
	Small Parts Insert 12 compartments LB 102 Made from 100% recycled polystyrene	4.50	160	1000010126

Product	Description	RRP in € excl. VAT	Pallet unit	Item number
	Foam Insert LB 102 pre-perforated for individual adjustment	15.60	140	6000003672
	Foam Insert Burner Nozzle LB 102 for 149 burner nozzles, ø 22 mm; resistant to heating oil	30.60	330	1000010144
	Cutting Insert Set LB 102 4 studded EPP sheets, 15 mm thick; incl. cutter	16.60	64	1000010146
	Anti-Slip Mat LB 102/136 prevents scratches on the bottom of the BOXX and protects the contents	4.90	500	1000010122
	Divider Set 3F LB 102 metal frame and dividers for division into 3 compartments	21.60	360	1000010149
	Divider Set 4F LB 102 metal frame and dividers for division into 4 compartments	23.70	440	1000010150
	Shoulder Strap Set LB * adjustable carrying strap	22.20	400	6000003684
	Labelling Stickers 10 sheets (DIN A4) with 18 weather-resistant labels & 79 icons	32.00		6100000403



* Mounting material included

Valid from 01.03.2024 - all prices are recommended retail prices

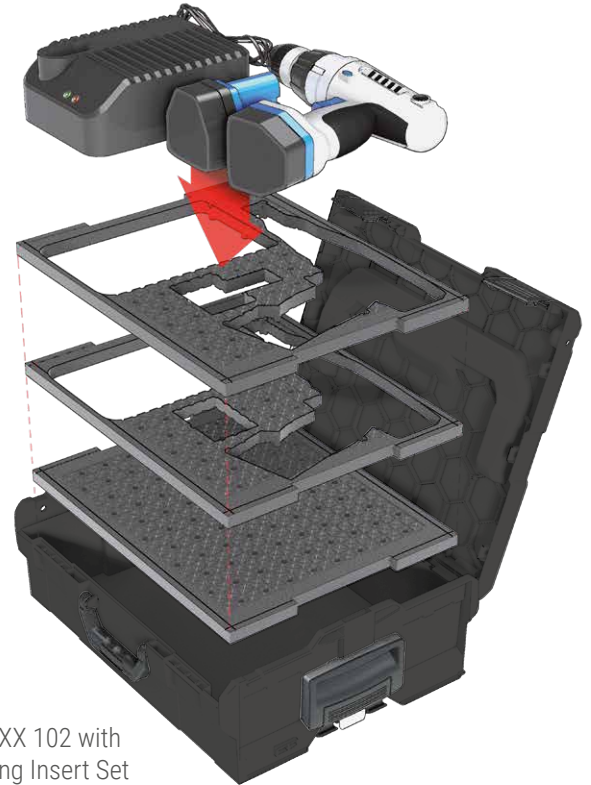

L-BOXX 102 with
Cutting Insert Set



L-BOXX 102 with Lid Insert
and Inset Box Set H3



L-BOXX 102 with Lid Insert
and Small Parts Insert with 8
compartments



L-BOXX 102 with Lid Insert
and Foam Insert



L-BOXX 102 with Lid Insert
and Inset Box Set L-BOXX Mini







L-BOXX 136 and matching accessories

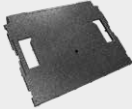

L-BOXX 136	RRP in € excl. VAT	Pallet unit	Item number
Colour: black / anthracite Exterior in mm: W445 x D358 x H152 Interior in mm: W378 x D310 x H101 Weight in kg: 2.2 Volume in litres: 13	54.40	65	6100000306









Tool case made of plastic for clear storage and protection during transport

Unique mobility system • Patented click connection • Modular interior • Organized storage • Safe transport • Integration into the in-vehicle equipment systems of renowned manufacturers

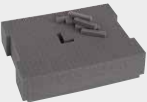
Product	Description	RRP in € excl. VAT	Pallet unit	Item number
	Lid Insert LB for flush lid closure for small parts inserts	6.20	240	6000003670
	Lid pads XLB Enables form-fit loading in conjunction with the Honeycombs in the lid for form-fit loading	4.30	500	6100000296
	Document Insert LB/XLB * for documents up to size DIN A4	23.10	200	6100000166
	Tool Insert 1 LB/XLB * with rubber loops and pockets for inserting tools	14.70	200	6100000164
	Tool Insert 2 LB/XLB * with rubber loops and pockets, can be equipped with tools on 3 sides	56.40	120	6100000165
	Small Parts Insert 4 compartments LB 136 Made from 100% recycled polystyrene	7.70	160	1000010127

* Mounting material included

Valid from 01.03.2024 - all prices are recommended retail prices

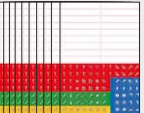
Product	Description	RRP in € excl. VAT	Pallet unit	Item number
	Small Parts Insert 6 compartments LB 136 Made from 100% recycled polystyrene	7.70	160	1000010128
	Small Parts Insert 8 compartments LB 136 Made from 100% recycled polystyrene	7.70	160	1000010129
	Foam Insert LB 136 pre-perforated for individual adjustment	17.10	80	6000003673
	Cutting Insert Set LB 136 6 studded EPP sheets, 15 mm thick; incl. cutter	20.40	40	6000003674
	Anti-Slip Mat LB 102/136 prevents scratches on the bottom of the BOXX and protects the contents	4.90	500	1000010122
	Divider Set 3F LB 136 metal frame and dividers for division into 3 compartments	22.50	384	1000010151
	Divider Set 4F LB 136 metal frame and dividers for division into 4 compartments	25.10	352	1000010152
	Shoulder Strap Set LB * adjustable carrying strap	22.20	400	6000003684
	Labelling Stickers 10 sheets (DIN A4) with 18 weather-resistant labels & 79 icons	32.00		6100000403

L-BOXX 136 with Lid
Insert and Divider Set
4F LB 136



L-BOXX 136
with Tool Insert 2



L-BOXX 136 with Lid
Insert and Small Parts
Insert with 8 compart-
ments



* Mounting material included

Valid from 01.03.2024 - all prices are recommended retail prices





L-BOXX 238 and matching accessories

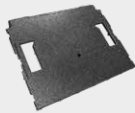

L-BOXX 238	RRP in € excl. VAT	Pallet unit	Item number
Colour: black / anthracite Exterior in mm: W445 x D358 x H254 Interior in mm: W378 x D303 x H203 Weight in kg: 2.8 Volume in litres: 25.5	60.70	35	6100000307

Tool case made of plastic for clear storage and protection during transport

Unique mobility system • Patented click connection • Modular interior • Organized storage • Safe transport • Integration into the in-vehicle equipment systems of renowned manufacturers

Product	Description	RRP in € excl. VAT	Pallet unit	Item number
	Lid Insert LB for flush lid closure for Inset Boxes and small parts inserts	6.20	240	6000003670
	Lid pads XLB Enables form-fit loading in conjunction with the Honeycombs in the lid for form-fit loading	4.30	500	6100000296
	Document Insert LB/XLB * for documents up to size DIN A4	23.10	200	6100000166
	Tool Insert 1 LB/XLB * with rubber loops and pockets for inserting tools	14.70	200	6100000164
	Hanging Insert LB 238/374 * second layer for L-BOXX 238 & 374 Colour: black Exterior in mm: W406 x D335 x H118 Interior in mm: W376 x D305 x H98 Weight in kg: 0.9 Volume in litres: 11	22.20	50	6100000292

* Mounting material included

Valid from 01.03.2024 - all prices are recommended retail prices

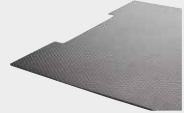
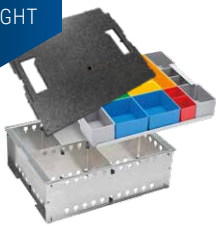
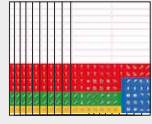
Product	Description	RRP in € excl. VAT	Pallet unit	Item number
HIGHLIGHT 	Thermo Insert LB 238 for the storage and transport of temperature-sensitive materials, incl. clamping holders in the lid insert for cartridge tips	32.00	12	1000010160
	Anti-Slip Mat LB 238 prevents scratches on the bottom of the BOXX and protects the contents	4.90	500	1000010123
HIGHLIGHT 	Divider Set 4F IBS H3 LB 238 Lid Insert, Inset Box Insert and Inset Box Set H3 as well as metal frame and dividers for division into 4 compartments	60.30	60	1000010155
	Labelling Stickers 10 sheets (DIN A4) with 18 weather-resistant labels & 79 icons	32.00		6100000403







L-BOXX 374 and matching accessories



L-BOXX 374	RRP in € excl. VAT.	Pallet unit	Item number
Colour: black / anthracite Exterior in mm: W445 x D358 x H390 Interior in mm: W378 x D294 x H339 Weight in kg: 3.5 Volume in litres: 41.5	65.20	25	6100000308

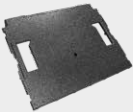

Tool case made of plastic for clear storage and protection during transport

Unique mobility system • Patented click connection • Modular interior • Organized storage • Safe transport • Integration into the in-vehicle equipment systems of renowned manufacturers

Product	Description	RRP in € excl. VAT	Pallet unit	Item number
	Lid Insert LB for flush lid closure for Inset Boxes and small parts inserts	6.20	240	6000003670
	Lid pads XLB Enables form-fit loading in conjunction with the Honeycombs in the lid for form-fit loading	4.30	500	6100000296
	Document Insert LB/XLB * for documents up to size DIN A4	23.10	200	6100000166
	Tool Insert 1 LB/XLB * with rubber loops and pockets for inserting tools	14.70	200	6100000164
	Hanging Insert LB 238/374 * second layer for L-BOXX 238 & 374 Colour: black Exterior in mm: W406 x D335 x H118 Interior in mm: W376 x D305 x H98 Weight in kg: 0.9 Volume in litres: 11	22.20	50	6100000292

* Mounting material included

Valid from 01.03.2024 - all prices are recommended retail prices

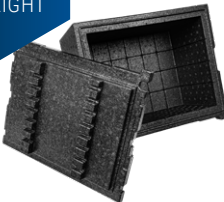
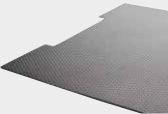
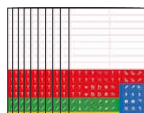
Product	Description	RRP in € excl. VAT	Pallet unit	Item number
	Silicone Cartridge Insert LB 374 half insert for LB 374, can be combined with one Foam Cartridge Insert	15.60	144	1000010141
	Foam Cartridge Insert LB 374 half insert for LB 374, can be combined with one Silicone Cartridge Insert	15.60	144	1000010142
HIGHLIGHT 	Thermo Insert LB 374 for the storage and transport of temperature-sensitive materials, incl. clamping holders in the lid insert for cartridge tips	36.80	8	1000010161
	Anti-Slip Mat LB 374 prevents scratches on the bottom of the BOXX and protects the contents	4.90	500	1000010124
	Labelling Stickers 10 sheets (DIN A4) with 18 weather-resistant labels & 79 icons	32.00		6100000403









XL-BOXX and matching accessories



XL-BOXX	RRP in € excl. VAT.	Pallet unit	Item number
Colour: black / anthracite Exterior in mm: W607 x D394 x H178 Interior in mm: W570 x D347 x H133 Weight in kg: 3.2 Volume in litres: 30.1	76.10	40	610000021







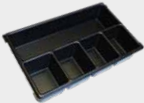

Large plastic tool case for clear storage and protection during transport

Unique mobility system • Click connection • Modular interior • Organized storage • Safe transport • Integration into the in-vehicle equipment systems of renowned manufacturers

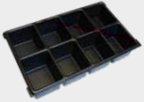
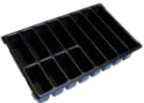
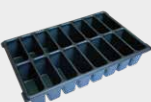
Product	Description	RRP in € excl. VAT	Pallet unit	Item number
	Lid Insert XLB for flush lid closure for Inset Boxes and small parts inserts	7.90	240	6100000081
	Lid Insert Small XLB for the L-BOXX inserts compatible compartment of the Divider Set	6.20	320	6100000080
	Lid Pads XLB enables form-fit loading in combination with the lid inserts	4.30	500	6100000296
	Document Insert LB/XLB * for documents up to DIN A4 size	23.10	200	6100000166
	Tool Insert 1 LB/XLB * with rubber loops and pockets for inserting tools	14.70	200	6100000164
	Tool Insert 2 LB/XLB * with rubber loops and pockets, can be equipped with tools on 3 sides	56.40	120	6100000165

* Mounting material included

Valid from 01.03.2024 - all prices are recommended retail prices

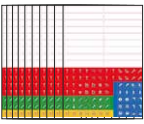
Product	Description	RRP in € excl. VAT	Pallet unit	Item number
	Small Parts Insert 5 compartments XLB Made from 100% recycled polystyrene	14.40	96	6100000148
	Small Parts Insert 6 compartments XLB Made from 100% recycled polystyrene	14.40	96	6100000150
	Small Parts Insert 8 compartments XLB Made from 100% recycled polystyrene	14.40	96	6100000151
	Small Parts Insert 12 compartments XLB Made from 100% recycled polystyrene	14.40	96	6100000152
	Small Parts Insert 16 compartments XLB Made from 100% recycled polystyrene	14.40	96	6100000153
HIGHLIGHT 	CAS Battery Insert XLB Made from 100% recycled polystyrene Insert for chargers and batteries of the Cordless Alliance System and the AMPShare-System	14.40	56	6100000366
	Inset Box Set XM XLB 1x XLB lid insert 9x XM XLB Inset Box	34.90	42	6100000910
	Foam Insert Set XLB 3-layer, pre-perforated	28.80	72	6100000170
	Cutting Foam Set XLB consisting of 5 LDF boards	28.80	72	6100000189
	Anti-Slip Mat XLB prevents scratches on the bottom of the BOXX and protects the contents	6.60	400	6100000168
HIGHLIGHT 	Divider Set XLB the Divider Set divides the XL-BOXX into up to five compartments and guarantees the safe holding of inserts in the L-BOXX format.	25.50	128	6100000097
	Labelling Stickers 10 sheets (DIN A4) with 18 weather-resistant labels & 79 icons	32.00		6100000403





XL-BOXX with Lid Insert and Lid Pads XLB



XL-BOXX with Tool Insert 2 and Divider Set XLB



XL-BOXX with Small Parts Insert 5 compartments and Lid Insert



XL-BOXX with Inset Box Set XM XLB and Lid Insert



LS-BOXX 306 and matching accessories











LS-BOXX 306	RRP in € excl. VAT.	Pallet unit	Item number
Colour: black / anthracite Exterior in mm: W445 x D358 x H322 Interior in mm: W388 x D309 x H98 Weight in kg: 3.8 Volume in litres: 13.5 (excl. tray)	81.90	25	6100000326
excluding LS-Trays or i-BOXX(es) Note: The upper compartment of the LS-BOXX 306 corresponds to the interior of the L-BOXX 136. This means that the respective accessories also fit into both BOXX types.			

Plastic tool case for clear storage and protection during transport

Unique mobility system • Patented click connection • Modular interior • Organized storage • Safe transport • Integration into the in-vehicle equipment systems of renowned manufacturers

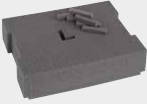
Product	Description	RRP in € excl. VAT	Pallet unit	Item number
	i-BOXX 72 * Interior in mm: W337 x D259 x H64 Volume in litres: 5.6	17.80	164	6100000336
	LS-Tray 72 * Interior in mm: W343 x D258 x H69 Volume in litres: 6.6	10.90	288	6100000337
	Lid Pads XLB enables form-fit loading in combination with the lid inserts	4.30	500	6100000296
	Lid Insert LB for flush lid closure for Inset Boxes and small parts inserts	6.20	240	6000003670
	Document Insert LB/XLB ** for documents up to DIN A4 size	23.10	200	6100000166

*Suitable accessories for the i-BOXX 72 and the LS-Tray 72 can be found from page 24 onwards. ** Mounting material included
Valid from 01.03.2024 - all prices are recommended retail prices

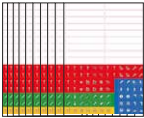
Product	Description	RRP in € excl. VAT	Pallet unit	Item number
	Tool Insert 1 LB/XLB ** with rubber loops and pockets for inserting tools	14.70	200	6100000164
	Tool Insert 2 LB/XLB ** with rubber loops and pockets, can be equipped with tools on 3 sides	56.40	120	6100000165
	Small Parts Insert 4 compartments LB 136 Made from 100% recycled polystyrene	7.70	160	1000010127
	Small Parts Insert 6 compartments LB 136 Made from 100% recycled polystyrene	7.70	160	1000010128
	Small Parts Insert 8 compartments LB 136 Made from 100% recycled polystyrene	7.70	160	1000010129
	Foam Insert LB 136 pre-perforated for individual adjustment	17.10	80	6000003673
	Cutting Insert Set LB 136 6 studded EPP sheets, 15 mm thick; incl. cutter	20.40	40	6000003674
	Anti-Slip Mat LB 102/136 prevents scratches on the bottom of the BOXX and protects the contents	4.90	500	1000010122
	Divider Set 3F LB 136 metal frame and dividers for division into 3 compartments	22.50	384	1000010151
	Divider Set 4F LB 136 metal frame and dividers for division into 4 compartments	25.10	352	1000010152
	Labelling Stickers 10 sheets (DIN A4) with 18 weather-resistant labels & 79 icons	32.00		6100000403



** Mounting material included

i-BOXX Rack Complete sets & individual components



		RRP in € excl. VAT.	Pallet unit	Item number
1 i-BOXX Rack 3-pieces * Colour: black / anthracite Exterior in mm: W445 x D342 x H305 Weight in kg: 4.3 Shelf-like mount for up to 3 i-BOXXes or LS-Trays. Fully compatible with the rest of the L-BOXX System.		97.90	25	6100000338
2 i-BOXX Rack 5-pieces * Colour: black / anthracite Exterior in mm: W445 x D342 x H475 Weight in kg: 6.5 Shelf-like mount for up to 5 i-BOXXes or LS-Trays. Fully compatible with the rest of the L-BOXX System.		141.60	15	6100000339
3 i-BOXX Rack active * Colour: black / anthracite Exterior in mm: W445 x D342 x H101 Weight in kg: 1.1 Single, shelf-like mount for i-BOXX or LS-Tray. Fully compatible with the rest of the L-BOXX System.		26.30	90	6100000333

Shelf-like receptacle for i-BOXX and LS-Tray. The modules can be combined with each other and expanded to fit all requirements

Organized storage • Patented click connection • Safe transport • Unique mobility system • Integration into the in-vehicle equipment systems of renowned manufacturers

Product	Description	RRP in € excl. VAT	Pallet unit	Item number
	Labelling Stickers 10 sheets (DIN A4) with 18 weather-resistant labels & 79 icons also compatible with i-BOXX and LS-Tray	32.00		6100000403

*without LS-Tray(s) or i-BOXX(es)!





i-BOXX 72 and matching accessories













		RRP in € excl. VAT.	Pallet unit	Item number
1 i-BOXX 72	Colour: black / transparent Exterior in mm: W367 x D316 x H73 Interior in mm: W337 x D259 x H64 Weight in kg: 0.9 Volume in litres: 5.6	 17.80	164	6100000336
2 LS-Tray 72	Colour: Black Exterior in mm: W370 x D314 x H73 Interior in mm: W343 x D259 x H69 Weight in kg: 0.6 Volume in litres: 6.6	 10.90	288	6100000337

Plastic assortment case for clear storage and protection during transport

Transparent lid for better overview • Clean storage • Safe transport • Unique mobility system • Modular interior layout

Product	Description	RRP in € excl. VAT	Pallet unit	Item number
	Inset Box Set A3 iB 72 1x Inset Box I3 25x Inset Box A3	13.60	100	6000010085
	Inset Box Set B3 iB 72 1x Inset Box I3, 12x Inset Box B3 1x Inset Box A3	13.60	100	6000010086
	Inset Box Set C3 iB 72 1x Inset Box I3, 5x Inset Box A3 2x B3, 4x C3	13.60	100	6000010087
	Inset Box Set H3 iB 72 1x each of Inset Box I3/D3/F3, 2x each of Inset Box B3/C3, 3x Inset Box A3	13.60	100	6000010088

Product	Description	RRP in € excl. VAT	Pallet unit	Item number
	Inset Box Set I3 iB 72 3x Inset Box I3, 6x Inset Box A3, 2x Inset Box B3	13.60	100	6000010089
	Small Parts Insert 4 compartments iB 72 Made from 100% recycled polystyrene	3.70	228	1000010130
	Small Parts Insert 7 compartments iB 72 Made from 100% recycled polystyrene	3.70	228	1000010131
	Small Parts Insert 8 compartments iB 72 Made from 100% recycled polystyrene	3.70	228	1000010132
	Small Parts Insert 9 compartments iB 72 Made from 100% recycled polystyrene	3.70	228	1000010133
	Small Parts Insert 12 compartments iB 72 Made from 100% recycled polystyrene	3.70	228	1000010134
	Small Parts Insert 14 compartments iB 72 Made from 100% recycled polystyrene	3.70	228	1000010135
	Small Parts Insert 16 compartments iB 72 Made from 100% recycled polystyrene	3.70	228	1000010136
	Small Parts Insert 18 compartments iB 72 Made from 100% recycled polystyrene	3.70	228	1000010137
	Small Parts Insert 20 compartments iB 72 Made from 100% recycled polystyrene	3.70	228	1000010138
	Wall Mount i-BOXX exposed holder, suitable for the workshop and the vehicle	21.50	160	1000010148



LT-BOXX 170 and matching accessories



LT-BOXX 170

Colour: black / anthracite
 Exterior in mm: W445 x D362 x H186
 Interior in mm: W378 x D310 x H163
 Weight in kg: 2.3
 Volume in litres: 20.1



RRP in €
 excl. VAT.
42.30

Pallet
 unit
 55

Item
 number
 6100000329

Tool box made of plastic for transport of bulky tools and protruding materials

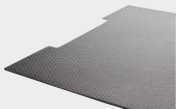
Wide swing-out carrying handle for maximum use of space and easy loading • Patented click connection • Clean storage • Safe transport • Unique mobility system • Integration into the in-vehicle equipment systems of renowned manufacturers

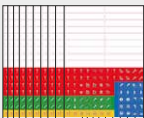
Product	Description	RRP in € excl. VAT	Pallet unit	Item number
	Anti-Slip Mat LB 102/136 suitable for the L-BOXX 102/136 and the LT-BOXX 170	4.90	500	1000010122
	Divider Set 3F LT 170 metal frame and dividers for division into 3 compartments	15.40	400	1000010153
	Labelling Stickers 10 sheets (DIN A4) with 18 weather-resistant labels & 79 icons	32.00		6100000403



LT-BOXX 170 with
 Divider Set 3F LT 170

LT-BOXX 272 and matching accessories



LT-BOXX 272	RRP in € excl. VAT.	Pallet unit	Item number
Colour: black / anthracite Exterior in mm: W445 x D362 x H288 Interior in mm: W378 x D303 x H265 Weight in kg: 2.7 kg Volume in litres: 32.2	51.40	35	6100000330

Tool box made of plastic for transport of bulky tools and protruding materials

Wide swing-out carrying handle for maximum use of space and easy loading • Patented click connection • Clean storage • Safe transport • Unique mobility system • Integration into the in-vehicle equipment systems of renowned manufacturers

Product	Description	RRP in € excl. VAT	Pallet unit	Item number
	Anti-Slip Mat LB 238 suitable for the L-BOXX 238 and the LT-BOXX 272	4.90	500	1000010123
HIGHLIGHT 	Divider Set 3F LT 272 metal frame and dividers for division into 3 compartments	22.50	176	1000010154
	Labelling Stickers 10 sheets (DIN A4) with 18 weather-resistant labels & 79 icons	32.00		6100000403



LT-BOXX 272 with
Divider Set 3F LT 272

L-BOXX Mini Deckel opak and matching accessories



L-BOXX Mini Opaque Lid food grade material

Colour: black / anthracite
 Exterior in mm: W295 x D155 x H63
 Interior in mm: W221 x D138 x H44
 Weight in kg: 0.3
 Volume in litres: 1.5

RRP in €
excl. VAT.

10.80

Pallet
unit

480

Item
number

6100000323

Packaging solution for small assortments made of plastic

Clean storage • 7 individually insertable dividers • Partitioning up to 6 compartments • Simple click connection • External dimensions in insert box grid

L-BOXX Mini Transparent Lid and matching accessories



HIGHLIGHT



L-BOXX Mini Transparent Lid food grade material

Colour: black / anthracite
 Exterior in mm: W259 x D155 x H63
 Interior in mm: W221 x D138 x H44
 Weight in kg: 0.3
 Volume in litres: 1.5

RRP in €
excl. VAT.

10.80

Pallet
unit

480

Item
number

6100000324

Packaging solution for small assortments made of plastic

Clean storage • 7 individually insertable dividers • Partitioning up to 6 compartments • Simple click connection • External dimensions in insert box grid

Product	Description	RRP in € excl. VAT	Pallet unit	Item number
	Foam Insert LB Mini pre-perforated patterns	7.50	400	1000010147

L-BOXX Micro 3-pieces Set and matching accessories



L-BOXX Micro 3-pieces Set

Colour: Transparent
 Exterior in mm: B259 x T106 x H42
 Interior in mm: B229 x T91 x H29
 Weight in kg: 0.18
 Volume: 0.68

RRP in €
excl. VAT.

9.90

Pallet unit

1350

Item number

6100001273

Transparent box for storage and transport of small parts

Order and overview guaranteed • Lightweight, robust and shatterproof • Simple click connection • 7 individually insertable label dividers
 Partitioning up to 8 compartments • Foldable Euro perforation • External dimensions in insert box grid



The flexible partitioning adapts to the load











Suited as a lunchbox due to food grade material



Neatly and clearly stored

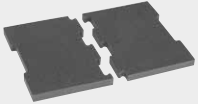



Can be fully integrated into the L-BOXX system thanks to grid dimensions

Product	Description	RRP in € excl. VAT	Pallet unit	Item number
HIGHLIGHT 	Trolley L-BOXX * Colour: grey-white Exterior in mm: W646 x D492 x H184 Weight in kg: 3.8 Burden in kg: 100 with four swivel castors, of which two are braked by an integrated brake	114.00	24	6100000340
	Fixing Strap for Trolley retraining strap with clamping lock for securing load on the trolley	18.10	330	1000010191
HIGHLIGHT 	Alu-Caddy Foldable Exterior in mm: W490 x D490 x H1090 Folded in mm: W490 x D60 x H760 Weight in kg: 6 Load in kg: 150 foldable caddy made of aluminium; including strap with push-in fastener	147.10	32	1000010121
	ProSafe Holder Set LB * can be screwed to the vehicle floor for clicking on BOXXes	16.60	30	1000010166
	ProSafe Clamping Lock Strap LB Length in mm: 1400	9.20	560	1000010162
	Seat Cushion Lid LB foam seat cushion splits for transportation in the L-BOXX	12.00	176	6100001410
	Mobile Worktop 1 part LB Depth in mm: 18 Weight in kg: 1.5	34.00	224	1000010158
	Mobile Worktop 2 parts LB Depth in mm: 14 Weight in kg: 1.5	31.60	304	1000010159
	Wall Mount i-BOXX exposed holder, suitable for the workshop and the vehicle	21.50	160	1000010148
	Shoulder Strap Set LB * adjustable carrying strap The pictured L-BOXX 136 is not included in the scope of delivery.	22.20	400	6000003684

* Mounting material included

Valid from 01.03.2024 - all prices are recommended retail prices

Product	Description	RRP in € excl. VAT	Pallet unit	Item number
	<p>Mobile Worktop 500x700 LB* Exterior in mm: W500 x D700 x H18</p> <p>The light, rugged and flexible Multi-plex work surface locks firmly with the BOXXes to be placed underneath. In combination with the trolley, the mobile workbench can be effortlessly transported to the construction site and quickly set up</p>	88.10	32	1000010163
	<p>Mobile Worktop 1400x700 LB* Exterior in mm: W1400 x D700 x H18</p> <p>The light, rugged and flexible Multi-plex work surface locks firmly with the BOXX towers. In combination with the trolley the mobile workbench can be effortlessly transported to the construction site and quickly set up</p>	141.40	20	1000010164



*Example application, only worktops are included in the scope of delivery.
Valid from 01.03.2024 - all prices are recommended retail prices

Tool Bag M



Technical data

Weight: 2.86 kg
Exterior: 480 x 260 x 330 mm

Item no.

6100000961

Pallet unit

30

RRP in €

72.90

Open tool bag with soft handle and shoulder strap

Zipper pocket with side velcro closure • Outside pockets • Flap pocket with velcro closure • Spirit level holder with velcro closure • Tape loops (inside) • Outside tape loops for Holder storage • UnitOrganizer • Reflective safety stripes • Clickable with the L-BOXX system • Adjustable shoulder strap with padding

Soft Bag M



Technical data

Weight: 2.21 kg
Exterior: 480 x 260 x 330 mm

Item no.

6100000966

Pallet unit

60

RRP in €

82.90

Closed tool bag with padded carrying handle and shoulder strap

Main compartment with 2-way zip • Tape loops for Holder storage • Open outer compartments • Flap pocket with velcro closure including open inner compartments • Zipper pocket with rubberised grip • Spacious outer pocket including inner tape loops • Open inner compartments • Integrated laptop pocket with velcro closure and rubber loops • Elastic straps inside • Adjustable shoulder strap with mesh padding • Clickable with the L-BOXX system • Reflective safety stripes

Soft Bag S



Technical data

Weight: 1.59 kg
Exterior: 350 x 330 x 220 mm

Item no.

6100000970

Pallet unit

80

RRP in €

62.90

Closed tool shoulder bag with rubberised carrying handle and shoulder strap

Flap with side zips and velcro closure • Open outer compartments • Outside zip pocket • Adjustable shoulder strap with mesh padding • Large main compartment on the back with velcro closure and trolley strap • Numerous inner compartments and rubber loops • Reflective safety stripes • Waterproof bottom made of PP • Clickable with L-BOXX Mini & L-BOXX Micro



Holder



Technical data		Item no.	Pallet unit	RRP in €
Weight:	0.08 kg	6100000971	3024	6.90
Exterior:	83 x 58 x 27 mm			

The core and most important connecting element of the ProClick system.
 Element for fastening to the belt • Safe clicking • Release only possible by unlocking button

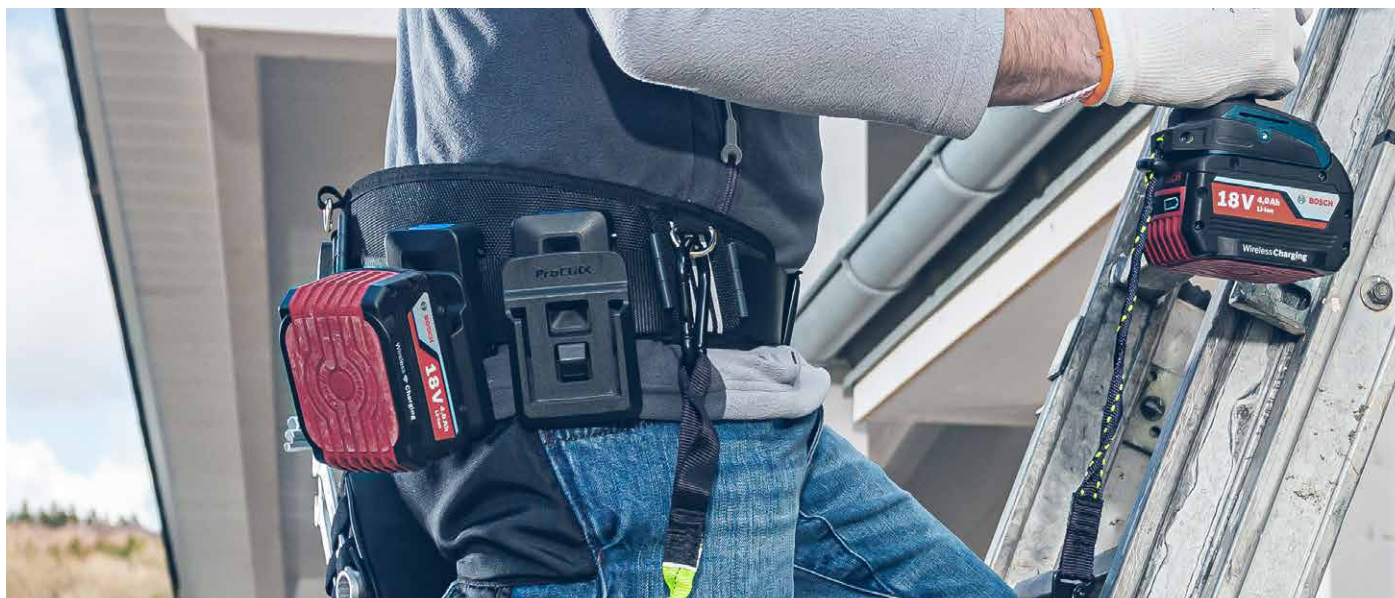

Tool Belt



Technical data

		Item no.	Pallet unit	RRP in €
Tool Belt S	Padding length: 800 mm Length-adjustable: 800-950 mm Weight: 0.48 kg	6100000957	384	31.90
Tool Belt M	Padding length: 900 mm Length-adjustable: 900-1150 mm Weight: 0.49 kg	6100000958		
Tool Belt L	Padding length: 1000 mm Length-adjustable: 1000-1350 mm Weight: 0.50 kg	6100000959		
Tool Belt XL	Padding length: 1200 mm Length-adjustable: 1200-1550 mm Weight: 0.51 kg	6100000960		

Padded tool belt with practical one-hand operation.

The length of the ergonomically padded belt is length-adjustable and adapts to any body size.



Suspenders



Technical data

Suspenders S/M	Padding length: 420 mm Length-adjustable: 900-1250 mm Weight: 0.36 kg	
Suspenders L/XL	Padding length: 520 cm Length-adjustable: 1050-1400 mm Weight: 0.40 kg	

Item no.

6100000967
6100000968

Pallet unit

408
408

RRP in €

29.90

Padded 4-point support system for tool belts

Carabiner for attachment to tool belt for ergonomic load balance on the body.

Breathable shoulder area • Ergonomic padding • Polyester strap for holding the ProClick Holder • Adjustable • Reflective safety strips • Open pockets • Pen loop

Tool Board S6



Technical data

Weight:	0.17 kg
Exterior:	210 x 160 x 40 mm

Item no.

6100000963

Pallet unit

1440

RRP in €

15.90

Tool belt holder for flexible transport of tools on the belt

Individual positioning and secure transport on the belt thanks to patented click connection between ClickUnit and Holder.

Elastic loops • Webbing loop for carabiner • Pen loops

Hammer Holder S



Technical data

Weight: 0.24 kg
Exterior: 210 x 160 x 100 mm

Item no.

6100000962

Pallet unit

624

RRP in €

18.90

Pivoting hammer holder for flexible transport of a hammer on the belt

Individual positioning and secure transport on the belt thanks to patented click connection between ClickUnit and Holder.

Webbing loop for carabiner • Pen loops • Pivoting hammer holder from left to right

Smart Pouch S



Technical data

Weight: 0.16 kg
Exterior: 200 x 120 x 70 mm

Item no.

6100000964

Pallet unit

900

RRP in €

18.90

Small tool belt pouch with flap for flexible and safe transport of sensitive equipment such as smartphones or measuring devices on the belt

Individual positioning and secure transport on the belt thanks to patented click connection between ClickUnit and Holder.

Pen loops • Webbing loop for carabiner • Recess for cable run

Nail Pouch



Technical data

Nail Pouch S
 Weight: 0.21 kg
 Exterior: 180 x 140 x 120 mm



Nail Pouch M
 Weight: 0.27 kg
 Exterior: 270 x 140 x 120 mm



Item no.

6100000965

Pallet unit

512

RRP in €

18.90

384

22.90

Tool belt pouch for flexible transport with integrated drawstring pocket that prevents consumables from falling out

Individual positioning and secure transport on the belt thanks to patented click connection between ClickUnit and Holder.
 Elastic loops • Webbing loop for carabiner • Drawstring bag made of soft polyester material

Tool Pouch M 14



Technical data

Weight: 0.27 kg
 Exterior: 270 x 140 x 120 mm

Item no.

6100000951

Pallet unit

384

RRP in €

22.90

Open tool belt pouch for flexible transport of tools on the belt

Individual positioning and secure transport on the belt thanks to patented click connection between ClickUnit and Holder.
 Elastic loops • Webbing loop for carabiner

Tool Pouch L 16



Technical data

Weight: 0.33 kg
Exterior: 270 x 220 x 120 mm

Item no.

6100000954

Pallet unit

192

RRP in €

26.90

Open tool belt pouch for flexible transport of tools on the belt

Individual positioning and secure transport on the belt thanks to patented click connection between ClickUnit and Holder.

Elastic loops • Webbing loop for carabiner

Tool Pouch L 36



Technical data

Weight: 0.52 kg
Exterior: 270 x 220 x 200 mm

Item no.

6100000955

Pallet unit

80

RRP in €

30.90

Open tool belt pouch for flexible transport of tools on the belt

Individual positioning and secure transport on the belt thanks to patented click connection between ClickUnit and Holder.

Elastic loops • Webbing loop for carabiner • Outer pocket compatible with inset boxes • Pen loop • Separate inner compartment • Kickstand



Tool Pouch L 39



Technical data

Weight: 0.55 kg
Exterior: 270 x 260 x 200 mm

Item no.

6100000956

Pallet unit

80

RRP in €

32.90

Open tool belt pouch for flexible transport of tools on the belt

Individual positioning and secure transport on the belt thanks to patented click connection between ClickUnit and Holder.

Elastic loops • Webbing loop for carabiner • Outer pocket compatible with inset boxes • Pen loop • Separate inner compartment • Kickstand • Hammer holder • Adjustable loop with buckle • Metal clip holder

UnitOrganizer



Technical data

Weight: 0.04 kg
Exterior: 200 x 40 x 17 mm

Item no.

6100000972

Pallet unit

1.200

RRP in €

9.90

Storage bar for all products equipped with a ClickUnit.

Available in a set of 2 incl. 4 screws for mounting on a wall or also in the vehicle interior.

Drill holes and screws for fixing at the wall

Battery Adapter Set 1.0



Technical data

Weight: 0.05 kg
Exterior: 74 x 98 x 36 mm

Item no.

6100000973

Pallet unit

1.440

RRP in €

8.90

Battery holder for safe carrying of a spare battery on the tool belt. Holder additionally required.

Suitable for the AMPShare battery system powered by Bosch, all commercially available CAS 18V and the Hilti B22 batteries.
Quantity per set: 2 x ProClick battery adapter



Individual positioning and secure transport on the belt thanks to patented click connection between ClickUnit and Holder.

Battery Mount Set 1.0



Technical data

Weight: 0.13 kg
Exterior: 73 x 120 x 48 mm

Item no.

6100000974

Pallet unit

1.152

RRP in €

9.90

Battery holder incl. holder for safe carrying of a spare battery on the tool belt.

Suitable for the AMPShare battery system powered by Bosch, all commercially available CAS 18V and the Hilti B22 batteries.
Quantity per set: 1 x ProClick holder, 1 x ProClick battery adapter



Individual positioning and secure transport on the belt thanks to patented click connection between ClickUnit and Holder.

ClickTray M 74









Technical data		Item no.	Pallet unit	RRP in €
Weight:	0.6 kg	6100000975	133	22.90
Exterior:	440 x 231 x 88 mm			
Interior:	365 x 226 x 75 mm			

Waterproof, clickable tray for storing tools or consumables.
 Integrated inset box grid • 2 coupling levers • Carrying in combination

ClickTray accessories

		RRP in € excl. VAT	Pallet unit	Item no.
	Foam Insert M 74 Pre-perforated raster foam for individual adjustment	15.60	240	6100001041
	Anti-Slip Mat M Soft insert mat to protect the ClickTray and the goods	4.90	500	6100001042
	Inset Box Set A3 CT M 74 28x Inset Box A3 red	13.60	114	6100000976
	Inset Box Set AB3 CT M 74 12x Inset Box A3 red 8x Inset Box B3 yellow	13.60	114	6100000977
	Inset Box Set B3 CT M 74 14x Inset Box B3 yellow	13.60	114	6100000978
	Inset Box Set BC3 CT M 74 6x Inset Box C3 blue 2x Inset Box B3 yellow	13.60	114	6100000979
	Inset Box Set CD3 CT M 74 4x Inset Box C3 blue 2x Inset Box D3 green	13.60	114	6100000980
	Inset Box Set H3 CT M 74 2x Inset Box A3 red, B3 yellow 2x Inset Box C3 blue, Box F3 orange 1x Inset Box D3 green	13.60	114	6100000981

Product	Description	RRP in € excl. VAT	Pallet unit	Item no.
	Inset Boxes A3 red single-variety packaging unit, 48 pieces	28.50	140	6000001817
	Inset Boxes B3 yellow single-variety packaging unit, 24 pieces	25.50	140	6000001818
	Inset Boxes C3 blue single-variety packaging unit, 12 pieces	23.20	140	6000001712
	Inset Boxes D3 green single-variety packaging unit, 8 pieces	22.40	140	6000001713
	Inset Boxes F3 orange single-variety packaging unit, 12 pieces	34.30	140	6000012257
	Inset Boxes G3 dark green single-variety packaging unit, 4 pieces	23.20	140	6000001819



ClickTray with
Foam Insert



ClickTray with
Inset Box Set H3













ClickTray with
Anti-Slip Mat





INSET BOXES Matrix



Inset Box (External dimensions in mm)	- L-BOXX 102 - W-BOXX 102	- i-BOXX 72 - LS Tray 72	- ProClick ClickTray M
 <p>Inset Box A3 red W52 x D52 x H63</p>			
 <p>Inset Box B3 yellow W104 x D52 x H63</p>			
 <p>Inset Box C3 blue W104 x D104 x H63</p>			
 <p>Inset Box D3 green W156 x D104 x H63</p>			
 <p>Inset Box F3 orange W208 x D52 x H63</p>			
 <p>Inset Box G3 dark green W312 x D104 x H63</p>			
 <p>Inset Box I3 grey (Inset Box + dividers) W260 x D78 x H63</p>			
 <p>Inset Box U3 grey (Inset Box + dividers) W312 x D60/71 x H63</p>			
 <p>Inset Box K3 grey (Inset Box + dividers) W312 x D130 x H63</p>			
 <p>L-BOXX Mini W260 x D156 x H63</p>			

Simply clear Our icons



Compatible with the Sortimo system



Maximum Lid load



Maximum load per BOXX: 25 kg



Compatible with the L-BOXX System



Clickable with the L-BOXX system



Maximum load per rack/i-BOXX: 5 kg



Inset box grid compatible



Maximum load per BOXX: 1.5 kg



Compatible with the Sortimo system



Maximum Belt width



Maximum load per bag: 12 kg



Compatible with the ProClick System



Clickable with the L-BOXX system



Maximum load per bag: 24 kg



Made from Polyester 1000D



Clickable with the ClickTray M 74



Maximum load capacity: 1 kg



Integrated ClickUnit for clicking on and off the holder



Clickable with the L-BOXX Mini



Maximum load capacity: 5 kg



Clickable with the L-BOXX Micro



Maximum load capacity: 24 kg



For the Transport



Suitable for series batteries



Suitable For stacking



Suitable for obsolete batteries



For storage



Suitable for prototypes



Suitable for damaged batteries

Battery SafeBOX

All prices excluding statutory VAT and delivery.

Suggested retail prices.

The publication of this list renders all previous lists invalid.

Product range valid from 01.03.2024



Work Clever. Click Together.
#ClickClever



Your dealer

www.L-BOXX.com/en
www.ProClick.de